

Model

HC-11UV Pro

HC-21UV Pro

Thank you very much for purchasing our “HOTCABI.”

CAUTION : Read the instructions before using the machine.

Contents

■Product Specifications.....1	■Checking Prior to Use and Setting.....8
■Safety Precautions.....2-5	■Sequence of Usage.....9
■Purpose of Use.....6	■Troubleshooting.....10
■Operational Mechanism.....6	■After-Purchase Servicing.....11
■Designation of Parts.....6-7	■Circuit Diagram.....12
■Safety Device.....7	



Product Specifications

Model	HC-11UV Pro	HC-21UV Pro
Rated voltage	Single-phase 120V 50 - 60Hz	
Power consumption	190W	380W
Safety device	Thermal fuse	
Temperature control	Microcomputer control	
Temperature	Hot : 70 - 80°C (when ambient temperature is under 30°C)	
UV lamp	GTL-2 (2W)	Two sets of GTL-2 (2W)
Cabinet dimensions	W450mm×D363mm×H322mm	W450mm×D363mm×H562mm
Inner box dimensions	W348mm×D207mm×H152mm	Two sets of W348mm×D207mm×H152mm
Cabinet capacity	11L (approx. 55 hand towels)	22L (approx. 110 hand towels)
Weight	7.5 kg	11.5 kg
Accessories	1×basket, 1×drain tray	2×baskets, 1×drain tray
Manufacturer	TAIJI & CO., LTD.	
Country of manufacture	Japan	



The specifications or appearance are subject to change without notice.





Safety Precautions

- Please peruse these “Safety Precautions” carefully so that you can use your product in the proper way.
- Please keep these “Safety Precautions” handy for future reference after being read.
- Precautionary measures referred to herein are matters which should be abided by for safe use and to prevent harm and/or damage being inflicted on yourself or others. Furthermore, the particulars of the precautionary measures have been classified into “Warning” and “Caution” to express the degree or extent of conceivable harm and damage which can be assumed to occur from mishandling. They are both of importance as far as safety is concerned and should be strictly abided by.









 WARNING	What is assumed to possibly result in death or serious injury.
 CAUTION	What is assumed to possibly result only in bodily injury or physical damage.





- What precautionary measures should be abided by are expressed by certain marks and explained as follows:









	⚠ indicates “Warning and caution is urged.” (The one on the left indicates beware of electrical shock.)
	⊘ indicates “Forbidden.” (The one on the left indicates disassembling forbidden.)
	● indicates “Instructions” which should be followed by all means. (The one on the left indicates grounding is a requirement.)

 WARNING	
 Attention required for setting	(1) To be set upon a stable and flat location and not to be moved while plug is connected to power source. Could result in abnormal performance.
 Disassembling forbidden	(2) Absolutely should not be disassembled, repaired, or modified by anyone other than a repair technician. Could result in ignition or abnormal performance.
 Dousing with water forbidden	(3) Do not immerse in or douse with water. Such could result in electric shock or short-circuit.
 Inspect and clean	(4) Periodically confirm that the plug contacts are kept clean and that they are firmly inserted in the power outlet. Dust accumulation or imperfect contact could be the cause of an electric shock or fire.







⚠ WARNING

 Forbidden	<p>(5) Handle the power cord with care. In case the power cord is processed, pulled, bundled, or a heavy item is placed upon or squeezes it, the cord is apt to be damaged and could cause an electric shock or fire. The power cord should not come into contact with a heat source.</p>
 Many loads on one electrical outlet forbidden	<p>(6) Ensure power source is from dedicated outlet of at least 15A. Using branch sockets could be the cause of abnormal heat, fire, etc.</p>
 Forbidden	<p>(7) Do not intentionally bend plug contacts to prevent the plug from dropping out of the electric outlet. Imperfect contact could be the cause of fire.</p>
 Removing plug	<p>(8) In the event of abnormal odor or sound, emission of smoke, or in case water or a foreign substance should enter the cabinet, switch off the unit immediately and remove the plug from the electric outlet. Such could possibly lead to an electric shock and outbreak of fire.</p>
 Wet hands forbidden	<p>(9) Do not touch or manipulate electrical parts such as the plug, power source switch, etc. with wet hands. It could be the cause of an electric shock.</p>
 Outdoors forbidden	<p>(10) Do not use outdoors. Using the product where there is rainfall could cause electric leakage and/or electric shock.</p>
 Discarding forbidden	<p>(11) Discarding of this product should be requested of specialized contractor, public agency, or the distributor from where the product was purchased. (A disposal fee is usually charged.) Discarding it at random could result in third party remodeling, using it for purposes other than as designed, which could result in an unexpected accident.</p>
 Attention required for using	<p>(12) This appliance can be used by children aged from 16 years and above and persons with reduced physical, sensory or mental capabilities or lack of experience and knowledge if they have been given supervision or instruction concerning use of the appliance in a safe way and understand the hazards involved.</p> <ul style="list-style-type: none"> - Do not allow to be used as a toy. - Close attention is necessary when used by or near children. - Cleaning and user maintenance shall not be made by children without supervision.

 WARNING	
 Forbidden	(13) Do not pull or carry by cord, use cord as a handle, close a door on cord, or pull cord around sharp edges or corners. Do not run equipment over cord.
 Grounding connection	(14) Ensure grounding is connected. Imperfect grounding could lead to electric shock.
 When not in use	(15) Switch off and remove the plug from electric outlet when not in use and before servicing. If you do not, it could be the cause of an electric shock, electric leakage fire, etc.
 Attention required for using	(16) Use only as described in this manual. Use only manufacturer's recommended attachments.

 CAUTION	
 Hold plug to remove	(1) Hold the plug and not the cord when removing the plug from the electric outlet. Not doing so could result in an electric shock or ignition.
 Caution	(2) Do not drop this product or inflict severe shock to it. It could result in failure or fire.
 Caution	(3) Discard immediately the polyethylene bag the product was packed inside. Keep it out of children's reach to prevent incidents of suffocation.
 Removing plug	(4) Remove the plug from the electric outlet as soon as thunder is heard. In the event of a nearby lightning strike, abnormal current/abnormal voltage could infiltrate through the power source line, etc. and possibly damage the product.
 Forbidden	(5) Do not use when the power cord or plug is damaged or when the electric outlet is loose. Using under such conditions could cause an electric shock, short-circuit, ignition, etc. If equipment is not working as it should, has been dropped, damaged, left outdoors, or dropped into water, return it to a service center.
 Forbidden	(6) Do not place heavy items or water containers on top of this product. Such could cause damage, injury, short-circuit, electric shock, corrosion, failure, etc.
 Forbidden	(7) Do not place heavy items on this product or place one's weight on it with its door open. Such could be the cause of damage or toppling.

CAUTION

 Caution! High temperatures	(8) To avoid burns, do not touch the surface of the inner cabinet when the machine is switched on. Use caution when taking out or placing towels in the inner box then.
 Use individually wrapped towels	(9) Use towels which come in polyethylene wrapper. Towels sometimes get dry or discolor if not polyethylene pouched. When using towels from home (as opposed to those provided by special suppliers), wring them out rather tightly (to some two and a half times the dry weight), place them in a polyethylene wrapper and seal the wrapped towels for use. However, despite being wrapped, towels left inside the inner box for longer periods may become towels dry or discolor.
 Use heat resisting polyethylene wrapper	(10) Use heat resisting (at least 120°C) polyethylene wrapper. When polyethylene or vinyl wrappers with a low heat resisting property are used, they may at times melt making towels useless, dry or cause discoloration.
 Use basket	(11) Always place towels on the basket and then store in this appliance. If not, wrapper could melt and make towels useless or cause discoloration.
 Forbidden	(12) Do not leave a towel within the inner box for more than one day. It could be the cause of discoloration and bad odor.
 Eliminating moisture	(13) Wipe off moisture within the inner box as well as the body after use and remove any foreign substances. Leaving moisture or any substances inside will cause the discoloration and bad odor of towels. It will also lead to malfunctioning when used thereafter. (14) Empty drain tray frequently. Accumulation of water could lead to overflowing and cause bad odor.

In case the plastic part of this product is touched with oily hands or the unit is placed where oil is used in large quantities, make it a rule to wipe plastic parts daily with a soft cloth soaked in neutral detergent solution diluted with hot water and dry off with a soft cloth.

* Plastic parts could at times become deformed or crack under the influence of oils, etc.

SAVE THESE INSTRUCTIONS

Purpose of Use

This product is an electric towel warmer for exclusive use indoors and is fabricated to warm wet towels.

Operational Mechanism

This product is equipped with a heating element to keep towels within the cabinet warm. By thermostat, the temperature within the cabinet will be maintained at 70°C - 80°C.

(The above indicates the temperature at the center of the inner cabinet when room temperature is 25°C)

Designation of Parts

HC-2 1 UV Pro

Operation panel

Power switch

Mode change switch

Mode indication



For upper box

LED (blue)

LED (orange)

LED (green)

For lower box

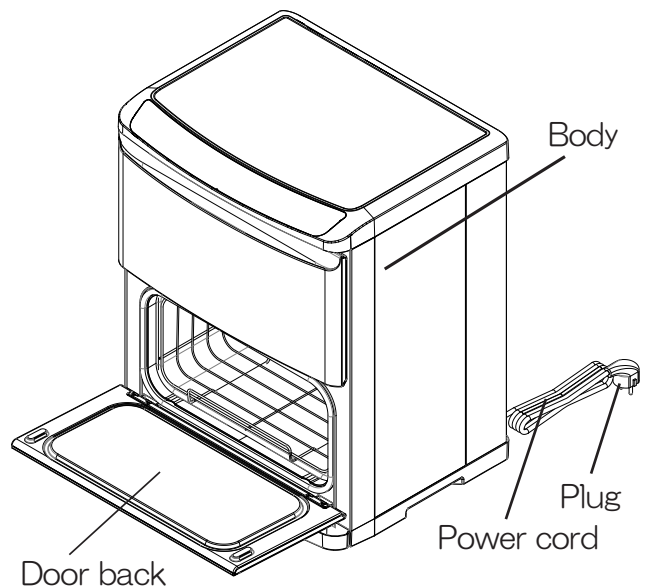

Body

Door back

Power cord

Plug

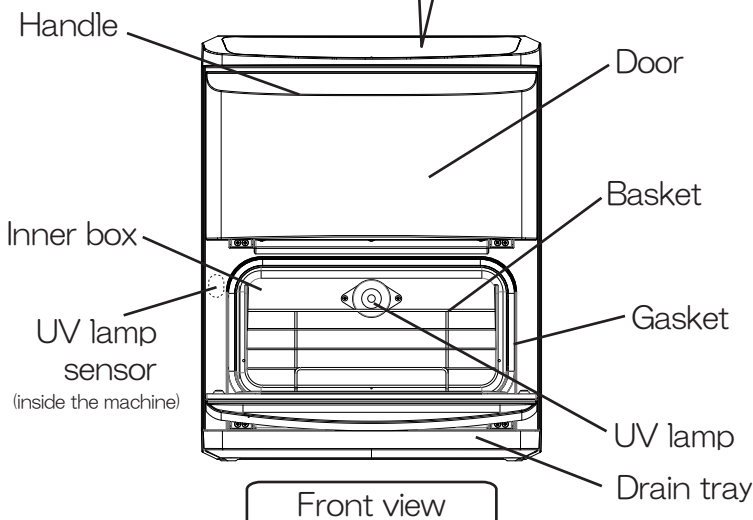

Front view

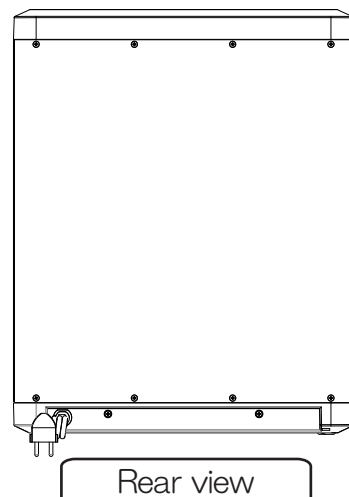

Rear view

HC-11UV Pro

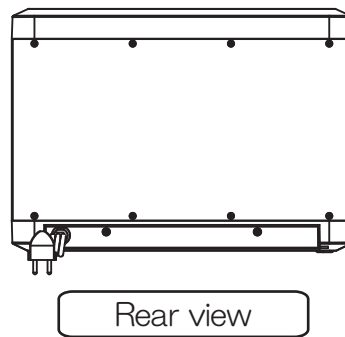
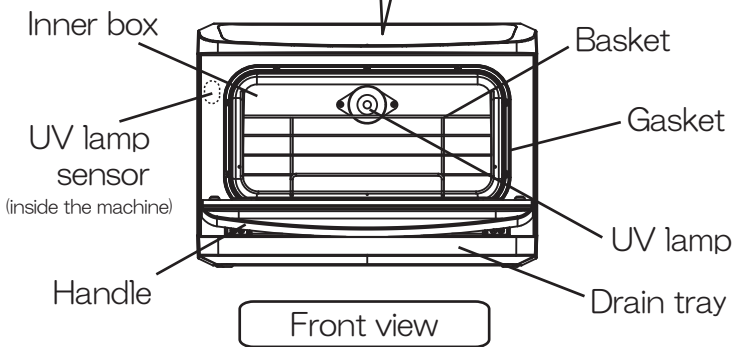
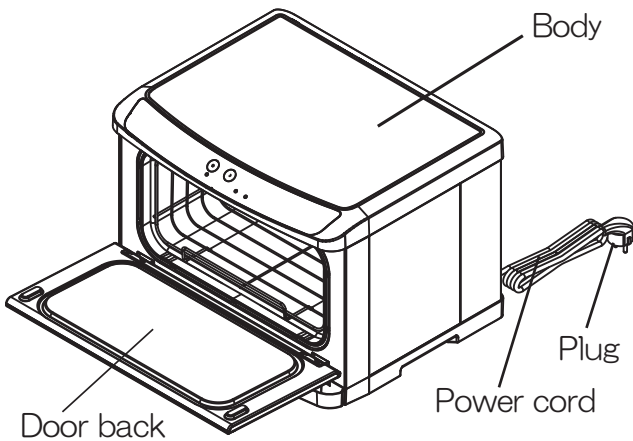
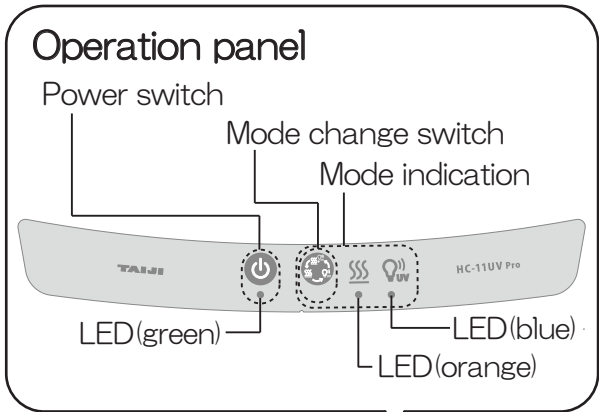

Safety Device

When the temperature of the product inside exceeds the upper limits abnormally by any means, the thermal fuse blows out the electric circuit.



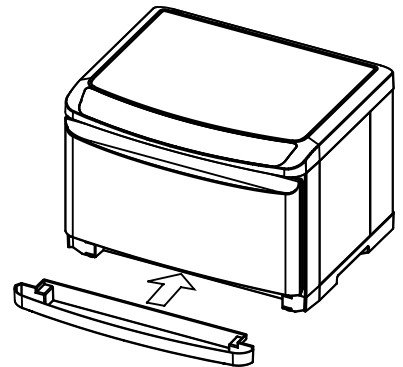

When it works turn off and take off the power plug from the power outlet and consult to TAJJI sales representative or TAJJI & CO., LTD.

Checking Prior to Use and Setting

1. Remove the product from packing carton and make sure that Instruction Manual and Accessories are included.
2. Set the product as follows:
 - At a place where it is flat and stable.
 - At a place where it is not affected by heat and avoid places where there is direct sunlight, and near stoves, microwave ovens, etc. (To be set away from such units by at least 50cm.)
 - Away from moist places or where it is susceptible to being splashed with water.
 - At a place where there is space all around the unit to allow ventilation.
3. Grounding
Ensure correct grounding is secured to protect against electric shock.
Consult with your dealer for details.
4. Affixing drain tray
 - Hold both sides of drain tray horizontally and push in until firmly inserted.
 - When water accumulates in the tray, remove and empty carefully.
Reinsert drain tray after being emptied.



Sequence of Usage

1. If moisture or dirt remains in the body or inner box, remove them with a dry towel etc.
2. Insert basket in the inner box and place wet rolled towels on the basket.
 - * In the event the amount of towels put into the box is low, place them on the basket as flat and as far apart as possible.
 - * The interior of the cabinet becomes heated from the surface. Place towels inside the cabinet so that they do not come into contact with such surfaces.
 - * When warm towels are needed in a hurry, please use towels that have been rolled after having been immersed in warm water.
 - * Put towels in heat resisting polyethylene wrap. If used without such wrapper, towels are apt to drying up quickly or becoming discolored.
3. Close the door tightly.
4. Insert the power plug, and then press the power switch .
 - * The LEDs of the power switch and the mode indication will light up.
 - * The product is set to heating  + UV lamp  mode primarily.
 - * When you change the mode, the changed mode will be memorized.
5. Press the mode change switch  to select your desired mode.
 - * The mode indication LED to be lit is changed every time you press the mode change switch.

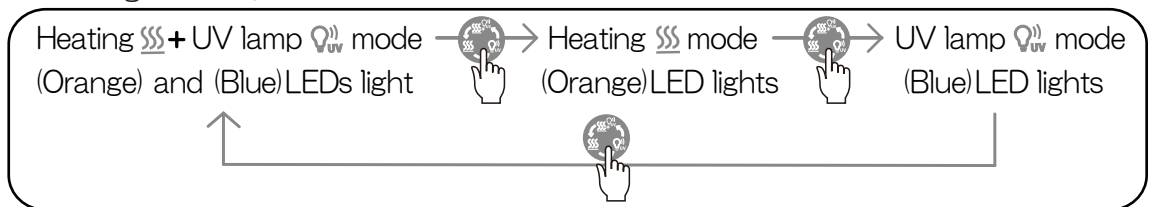

WARNING:

This appliance contains a UV emitter. Do not stare at the light source. In order to prevent excessive when exposure of radiation, switch off and remove the plug from electric outlet before service.

Post-use Instructions

1. Switch off and remove plug from electric outlet.
2. Take out remaining towels, etc. and wipe inner box clean to remove residual moisture.
3. Empty water accumulated in the drain tray. Wash clean when considerably stained.
4. Stains on the body should be wiped clean with a dry cloth or a tightly wrung wet cloth.
 - * Use a neutral detergent when stains are severe. Do not use cleansers containing abrasives or solvents such as paint thinners.
 - * The appliance shall not be cleaned with a water jet.
5. Leave the door of the cabinet open for a while for moisture to dry as a means to prevent odors.

About the UV lamp

UV lamp is lit when heating + UV mode or UV mode is selected and the door is closed.

● Checking UV lamp performance

*Do not stare at the light source directly.

To check if the UV lamp is lit or not, light the UV lamp while putting the magnet close to the UV lamp sensor. At this time, look at the end of the inner box, but do not stare at the light source. If the light does not work even after trying this operation several times, it can be assumed that the UV lamp has burned out. In this case, consult to TAJI sales representative or TAJI & CO., LTD.

● Replacing the UV lamp

1. Turn off the power switch, and remove the plug from the outlet.
2. Remove the two screws of the lamp holder to remove the lamp holder and the protective net.
3. Remove the UV lamp by turning it to the left. The rubber socket will also be removed with the lamp.
4. Remove the rubber socket from the UV lamp, and set it on a new UV lamp.
5. Attach the new UV lamp on which the rubber socket has been set by turning it to the right.
6. Fix the lamp holder and the protective net with the two mounting screws.

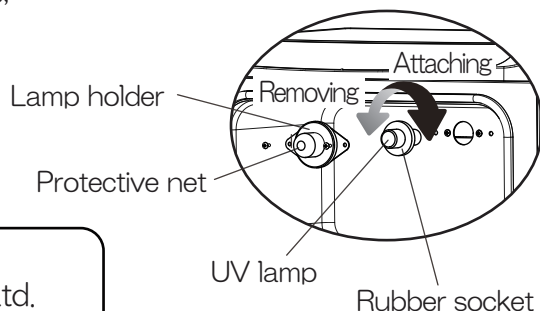
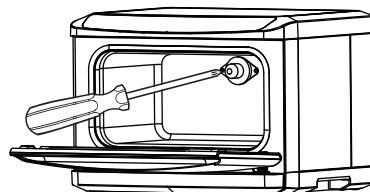

Replacement lamp

Manufacturer : SANKYO DENKI Co., Ltd.
Part number : GTL2

WARNING :

To prevent excessive rays from the UV lamp, turn off the power switch and remove the plug from the outlet before maintenance work.

If an indication below appears

Remove the power plug once, and then switch on the power again.
If normal status cannot be recovered even after doing that,
confirm the error details and request repair.

Indication	Details/Countermeasures
LED (green) blinks	An error in the temperature sensor.
LED (orange) blinks	An error in the temperature control. It can be assumed that heat has been generated and the temperature has risen exceeding the normal range. ●Check the installation condition. → Install the product by following the instructions on page 8.

Troubleshooting

Situation	Details/Countermeasures
The LED of the power switch does not light up.	<ul style="list-style-type: none"> ●Is the power plug disconnected?
It does not become heated even after waiting for a while.	<ul style="list-style-type: none"> ●Is the power plug disconnected? ●Are there any abnormal indications? *Check "If an indication below appears" above.
Noises are heard during use.	<ul style="list-style-type: none"> ●Is the product installed in a stable and flat location? ●Noises are heard from the fan that cools the components. ●Small noises can be heard during use or immediately after use owing to expansion or contraction in the surface inside the inner box, but it is not a failure.
There is an abnormal smell.	<ul style="list-style-type: none"> ●Have you wiped off dirt and moisture attached to the inside of the inner box regularly? ●Have you emptied water accumulated in the drain tray regularly?

After-Purchase Servicing

For after sales service, contact the store where you have purchased your towel warmer, or nearest TAJI sales representative or TAJI & CO., LTD. in Japan. If the supply cord is damage, it must be replaced by its service agent or similarly qualified persons in order to avoid a hazard.

TAJI & CO., LTD.

8-2, Okawa-cho, Kawasaki-ku, Kawasaki-shi, Kanagawa, 210-0858 Japan

TEL : +81-44-329-6338, FAX : +81-44-326-5860

E-mail : overseas@taiji.co.jp

URL : <http://www.taiji.co.jp/e>

Circuit Diagram

HC-1 1 UV Pro

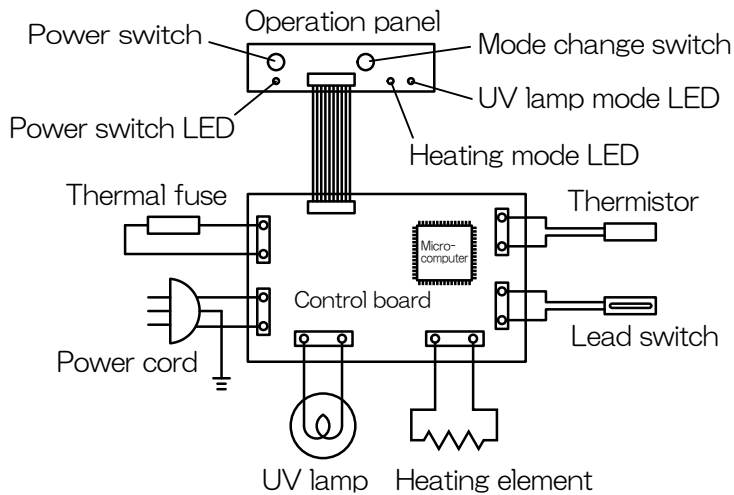

HC-2 1 UV Pro

